



# ART 363M ART 363ME

REV 00.2022  
FOIST00103

PRODOTTO ED ASSEMBLATO IN ITALIA / MADE AND ASSEMBLED IN ITALY / FABRIQUÉ ET ASSEMBLÉ EN ITALIE / HECHO Y MONTADO EN ITALIA

## CARATTERISTICHE • FEATURES • CARACTÉRISTIQUES • CARACTERÍSTICAS

Sistema girevole con piastra di fissaggio sul fondo ad 1 piano, vassoio in nobilitato, per angolo base 900x900 mm (90°)  
Rotating system with bottom fixing plate, 1 shelf in melamine chipboard, for 900x900 mm (90°) corner base unit  
Système tournant avec plaque de fixation dans le fond, 1 panier en bois mélaminé, pour meuble angle base de 900x900 mm (90°)  
Sistema giratorio con placa de fijación en el fondo, 1 bandeja en melamina, para mueble esquinero base de 900x900 mm (90°)

## MINUTERIA INTERNA • FITTINGS • FERRURE • FERRETER

N°8 pz 6.3x14 mm Eurovite per ripiano / Euro screw each shelf / Euro vis for étagère / Tornillo Euro por estant

## COMPONENTI • PARTS • COMPOSANTS • COMPONENTES

- A. Cesto Art 363M-363ME / Basket Art 363M-363ME / Panier Art 363M-363ME / Cesto Art 363M-363ME
- B. Dima di foratura / Drilling template / Gabarit de perçage / Plantilla de perforació
- C. Piastra girevole / Rotating plate / Plaque tournante / Placa giratoria
- D. N°2 363ME Sponda / Insert / Insert / Lateral

## UTENSILERIA • TOOLS • OUTILS • INSTRUMENTOS



## MANUTENZIONE • MAINTENANCE • ENTRETIEN • MANTENIMIENTO

Pulire con un panno morbido ed asciutto. Evitare l'uso di solventi e/o abrasivi.  
Clean with a soft, dry cloth. Avoid using solvents or abrasive.  
Nettoyez avec un chiffon sec et doux. N'utilisez pas aucun solvant ou produit abrasif.  
Limpiar con paño suave y seco. Evitar el uso de solventes y/o abrasivos.

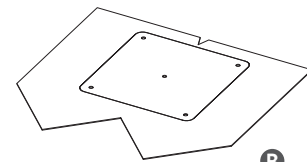
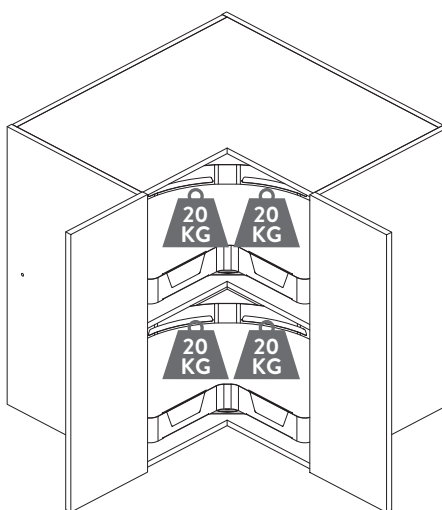
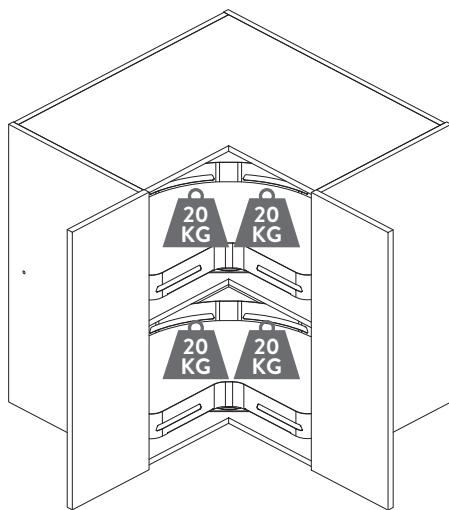
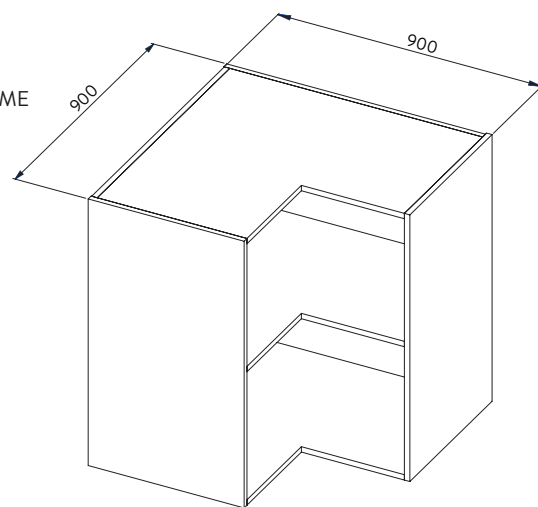

B

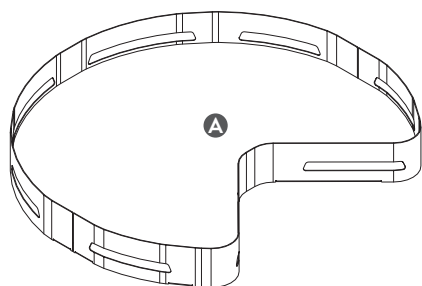

ART 363M

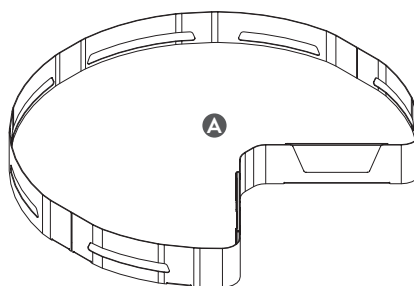

ART 363ME

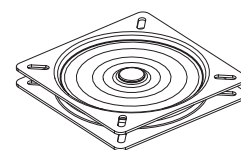

C

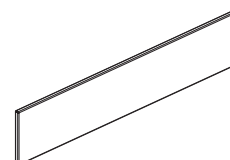

D

N°4 6,3x14



1

Fissare la piastra girevole C nella parte inferiore del vassoio con le apposite viti.

Fix the rotating plate C to the underside of the carousel basket by using the specific screws.

Fixez la plaque tournante C dessous le panier avec les propres vis.

Fijar la placa giratoria C en la parte inferior del cesto utilizando los tornillos específicos.

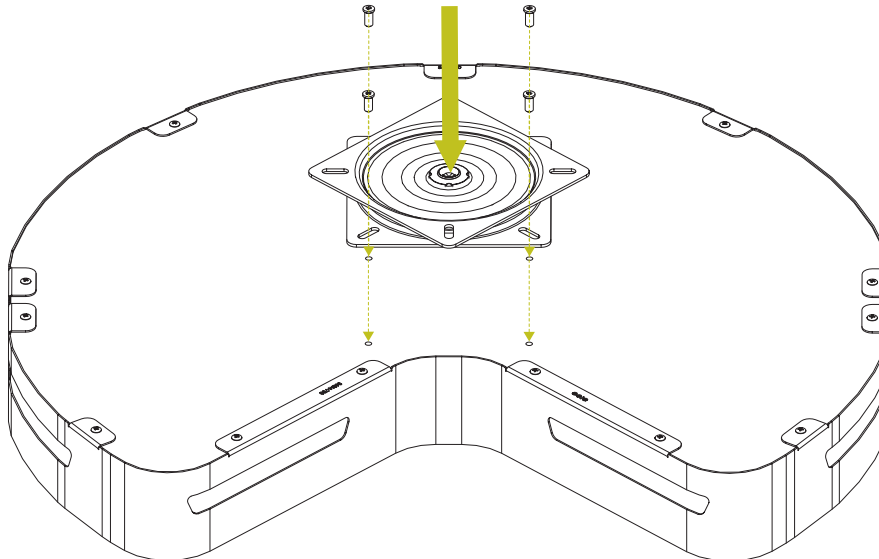

2

Posizionare la dima di foratura B nel ripiano ed effettuare i fori con la punta da 5mm per un'altezza di 12mm.

Place the drilling template B on the shelf and drill it with a 5mm drill bit for a depth of 12mm.

Mettez le gabarit de perçage B dans l'étagère et percez-le avec un foret de 5mm pour une profondeur de 12mm.

Poner la plantilla de perforación B en el estante y perforar con la broca de 5mm por 12mm de profundidad.

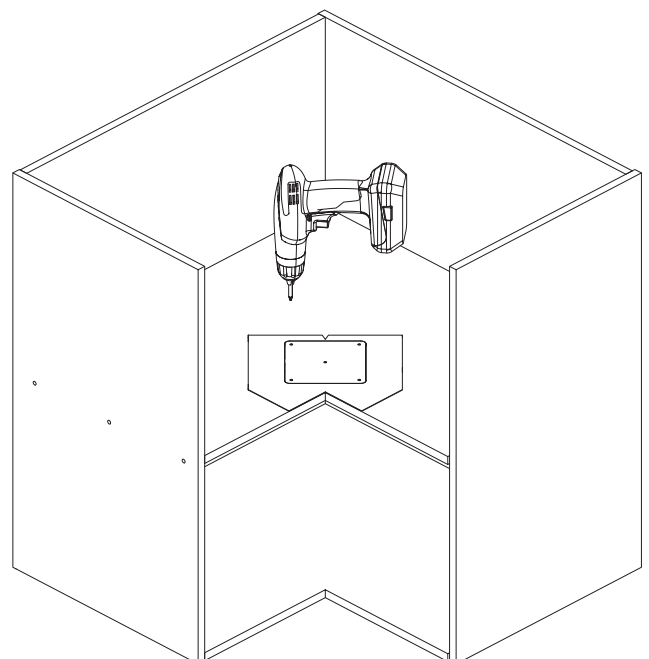
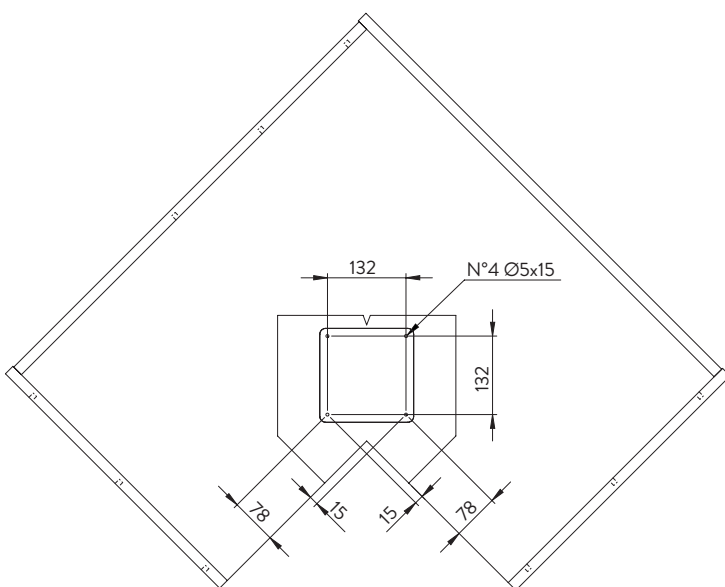

**3**

Posizionare il vassoio all'interno del mobile.  
 Put the carousel basket inside the cabinet.  
 Mettez le panier tournant dans le meuble.  
 Poner el cesto giratorio dentro el mueble.

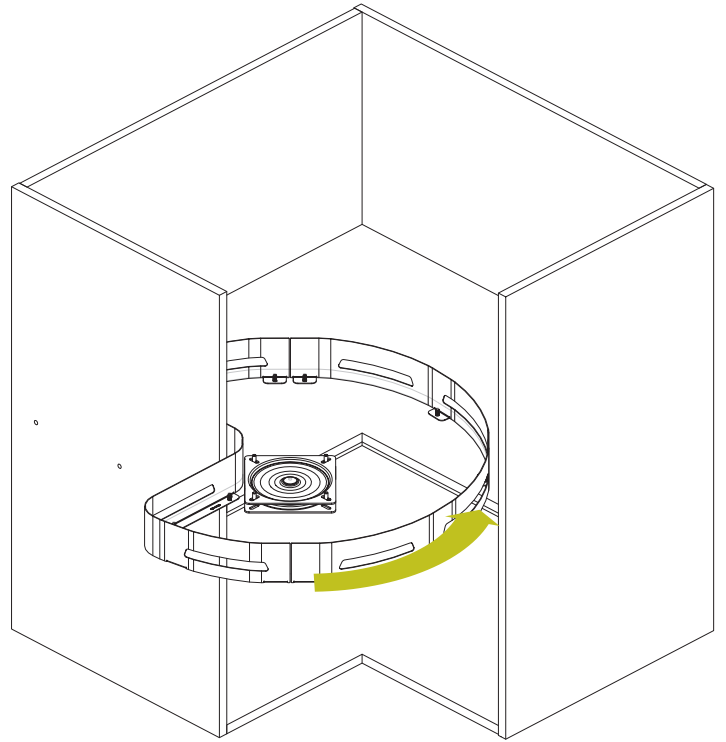
**N°4 6,3x14**

Avvitare la piastra sul ripiano ruotando il vassoio come foto.

Screw the rotating plate on the shelf turning the carousel basket, as shown in the picture.

Vissez la plaque tournante sur l'étagère en tournant le panier, comme dans la photo.

Atornillar la placa giratoria en el estante y rotar el cesto, como se muestra en la imagen.

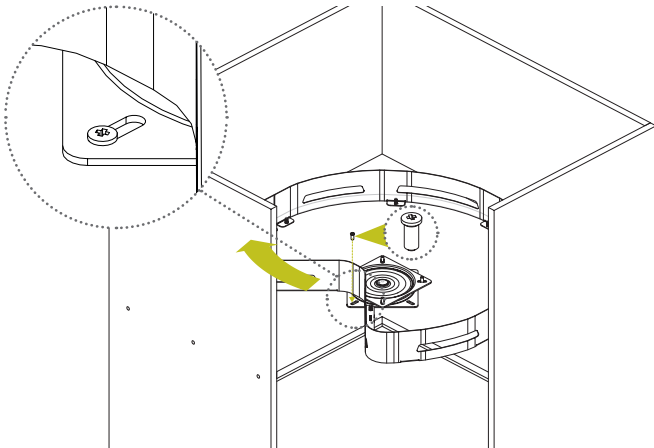
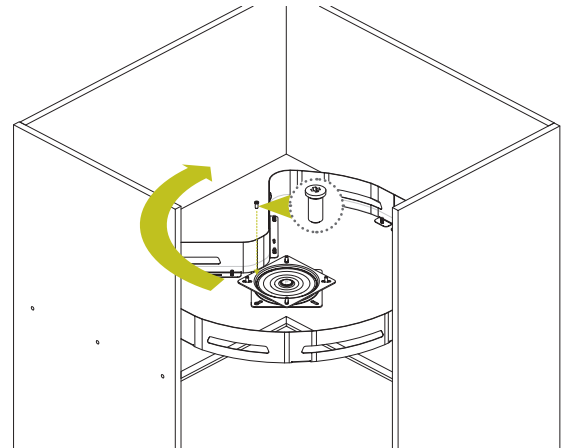
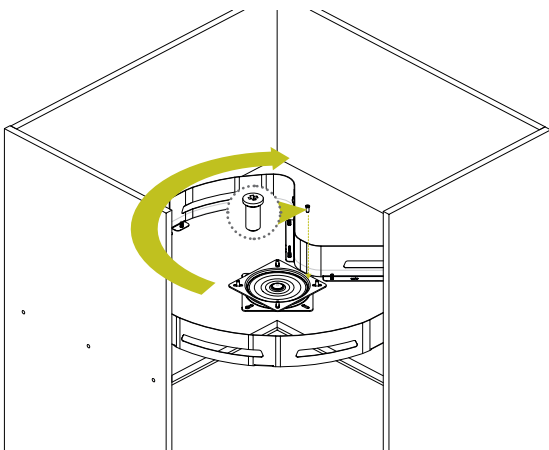
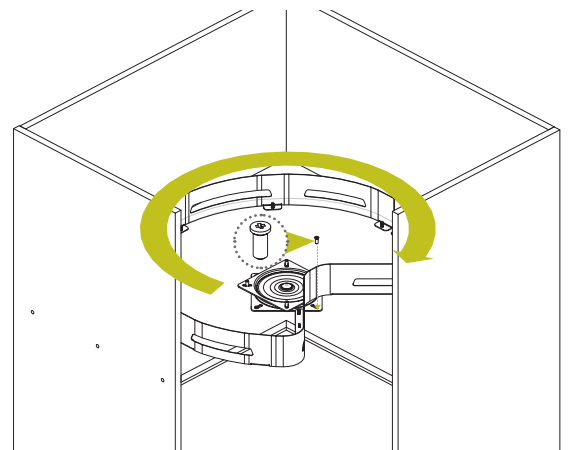
**1****2****3****4**

**5**

Fissare le antine.  
 Fix the cabinet doors.  
 Fixez les portes du meuble.  
 Fijar las puertas de mueble.

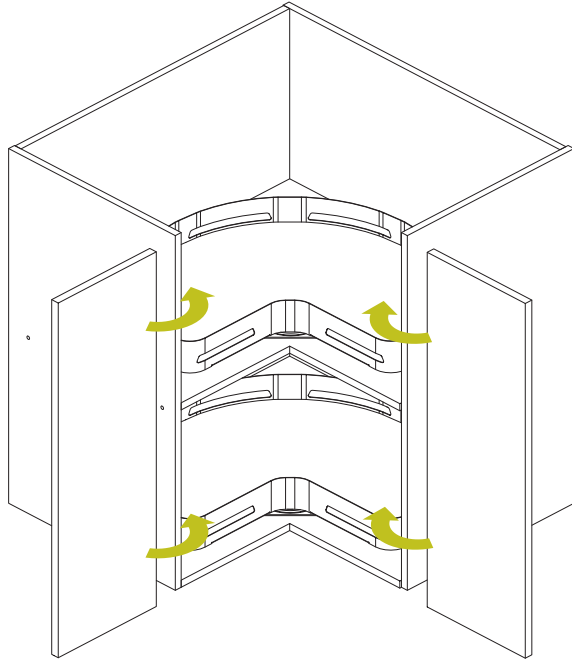
**6**

Se si desidera assemblare il secondo ripiano ripetere tutte le fasi.  
 If you would like to assemble a second carousel basket, please repeat all the steps.

Si vous voulez fixer le deuxième panier, répétez toutes les étapes.  
 Si usted quiere montar un segundo cesto, repetir todos los pasos.

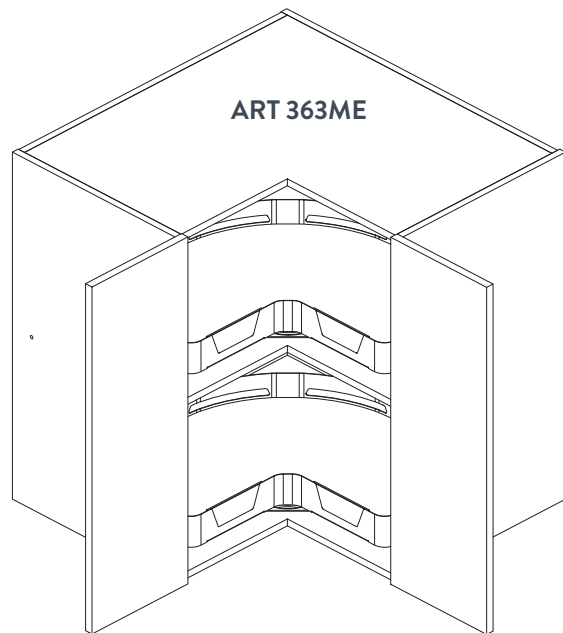
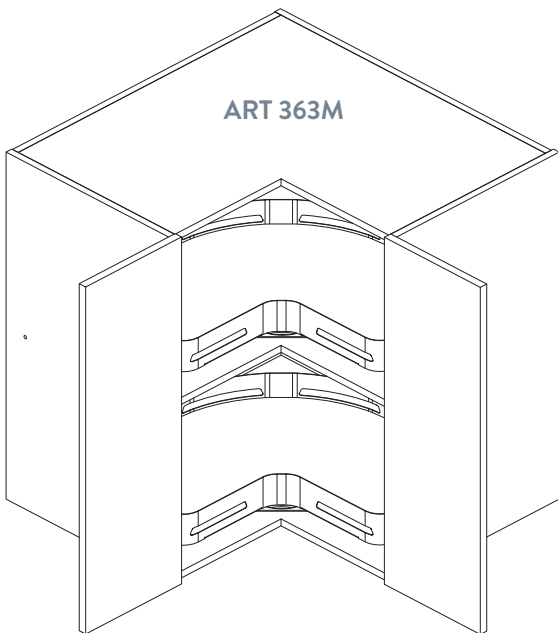

## OPTIONAL ART 363ME

Sponda / Insert / Insert / Lateral

